

### 3a. Accessori per raccordi a stringere e a pressare 3a. Accessories for screw and press fittings

3.3 - Doppia\* staffa a murare per raccordi 2.9 /A e /B. In acciaio zincato, con viti di fissaggio, interasse fisso.

*Wall mounting plate for 2.9/A e /B. Galvanized flat steel including fixing material, distance between fittings is fixed.*

Codice	Interasse mm	Confezione (pz)	€/cad
W3031530	153	5	2,85
W3032000	200	5	3,00

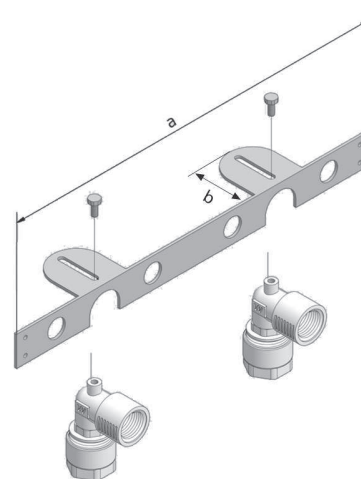
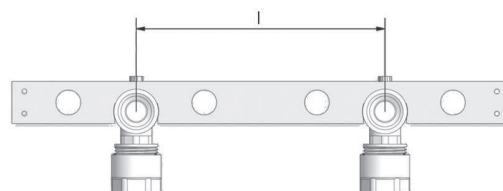

3.4 - Doppia\* staffa a murare per raccordi 2.10-11 /A e /B - 4.71/72-4.81/82. In acciaio zincato, con viti di fissaggio, interasse regolabile.

*Wall mounting plate for fittings 2.10-11/Ae/B - 4.71/72-4.81/82. Galvanized flat steel including fixing material, distance between fittings is adjustable.*

Codice	Interasse mm	Confezione (pz)	€/cad
W3042200	150÷220	5	2,50
W3042210 <sup>(1)</sup>	150÷220	5	2,67

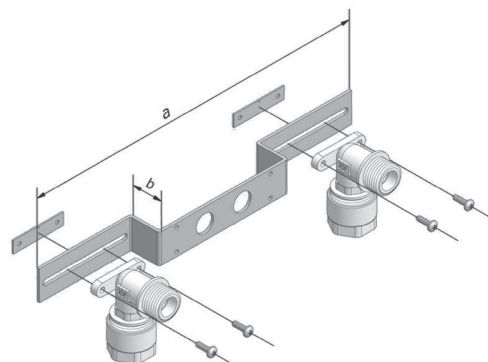
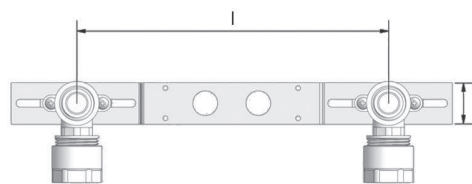

\* Predisposizione al sezionamento per uso singolo.  
(1) Per raccordi con staffa grande (Art. n° 4.72-4.82-4.73).

\* It's possible to cut plate for only one elbow.  
(1) Only for fittings 4.72/73-4.82.

3a. Accessori per raccordi a stringere e a pressare  
 3a. Accessories for screw and press fittings

3.5 - Doppia staffa a murare per raccordi a stringere 2.10-11/A e /B e a pressare 4.71-72-81-82. In acciaio zincato con viti di fissaggio. Interasse fisso 80 mm.

Wall mounting plate for screw fittings 2.10 – 11/A e /B and press-fittings 4.71-72-81-82. Galvanized flat steel including screws. Fixed distance between fittings: 80 mm.

Codice	Interasse mm	Confezione (pz)	€/cad
W3050080	80	2	2,98

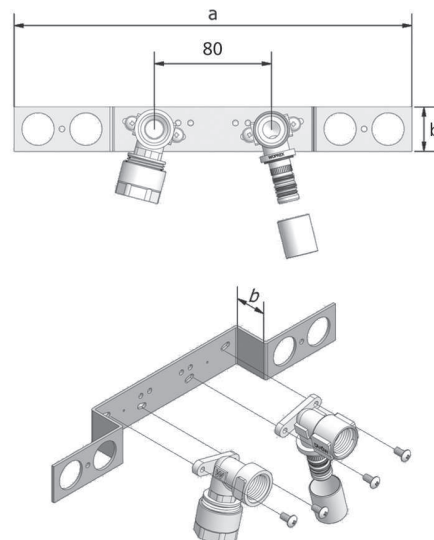

3.55 - Doppia staffa a murare con interasse regolabile, utilizzabile con tutti i nostri raccordi (stringere e pressare) dotati di staffa (2.10/A-B, 4.6, 4.63, 4.71-72-81-82); in acciaio zincato, completa di 4 supporti scorrevoli in plastica.

Wall mounting double plate, adjustable distance between fittings, able for all our fittings with flange (2.10/A-B, 4.6, 4.63, 4.71-72-81-82). Galvanized flat steel with 4 plastic sliding supports.

Codice	Interasse mm	Confezione (pz)	€/cad
W3557524	80-240	2	3,86

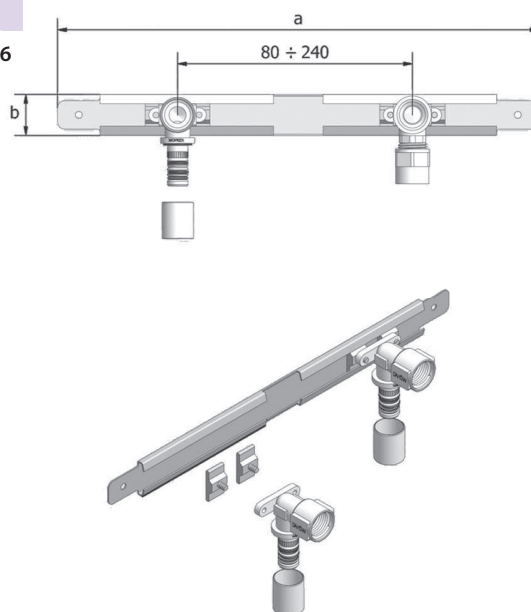

3a. Accessori per raccordi a stringere e a pressare  
 3a. Accessories for screw and press fittings

4.36/A - 4.36/B - Coppia staffe a murare per raccordi 2.35 e 4.35. In acciaio zincato con viti di fissaggio.  
 Double mounting plate for 2.35/A. Galvanized flat steel including fixing material.

Codice	Articolo	Confezione (pz)	€/cad
W4360000	4.36/A - Staffa	1 coppia	5,30
W4360001	4.36/B - Dima		1,91

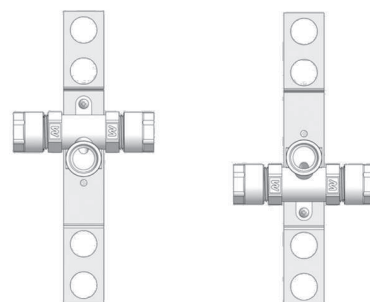

A	B	C	D
240	200	153	100

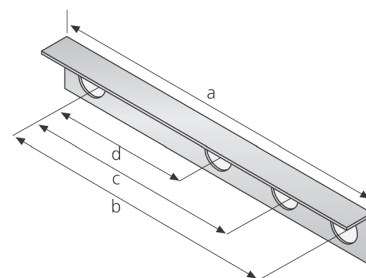

2.21 - Manicotto estensibile per riparazioni e/o modifiche.\* Esecuzione nichelata.  
 Expansion screw joint. Nickel-plated.

Codice	Diametro mm	Confezione (pz)	€/cad
W2211610	16x2,25	1	20,64

Prodotto disponibile fino ad esaurimento scorte di magazzino.

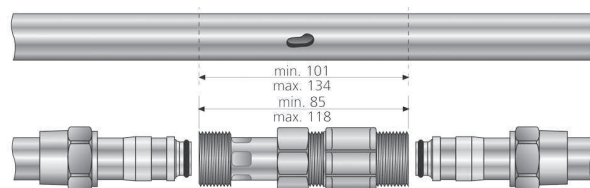
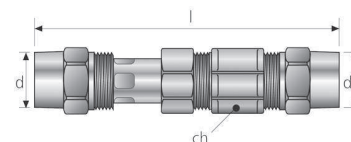

### 3a. Accessori per raccordi a stringere e a pressare 3a. Accessories for screw and press fittings

#### 2.22 - Set comprendente n° 3 O-ring e n° 1 guarnizione di testa. Set with 3 O-rings and gasket.

Codice	Diametro mm	Confezione (pz)	€/set
WSET0W14	14x2,00	12 set	0,28
WSET0W16	16x2,25	12 set	0,34
WSET0M16	16x2,00	12 set	0,34
WSET0W20	20x2,50	12 set	0,42
WSET0M20	20x2,00	12 set	0,42
WSET0W26	26x3,00	12 set	0,52



#### 4.34 - Tappo prova riutilizzabile per tubi WELCO-Flex - Teck. In ottone nichelato. Con attacco per tappo o valvolina sfogo aria. Maletthread plug for multi-layer pipe. In nickel plated brass with connection for air vent valve.

*Maletthread plug for multi-layer pipe. In nickel plated brass with connection for air vent valve.*

Codice	Diametro mm	Diametro 1 mm	Confezione (pz)	€/cad
W4341614	16x2,25	1/4" F	20	5,77
W4342014	20x2,50	1/4" F	20	5,77
Gli articoli sotto riportati sono per tubo con spessore 2,00 mm				
M4341414	14x2,00	1/4" F	20	5,77

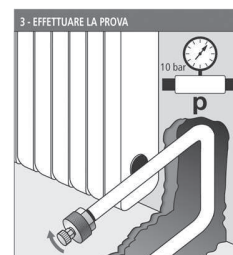
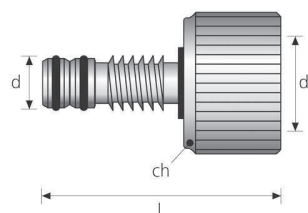

#### 3.8 - Tappo con guarnizione. Plug with gasket.

Codice	Articolo	Confezione (pz)	€/cad
W3081200	TP12	100 <sup>(1)</sup>	1,01

(1) Se non specificato 50 pezzi rossi, 50 pezzi blu.

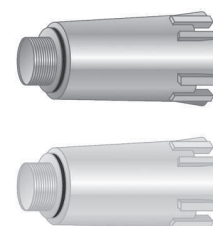

3a. Accessori per raccordi a stringere e a pressare  
 3a. Accessories for screw and press fittings

3.81 - Prolunghe cilindriche.  
 Extension cylindrical brass.

Codice	Diametro mm	l	Confezione (pz)	€/cad
W2A21210	1/2"	10	24	3,40
W2A21220	1/2"	20	24	3,76
W2A21230	1/2"	30	24	4,45

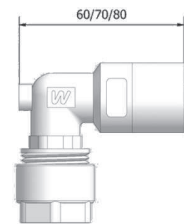
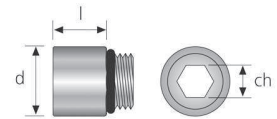

4.33 - Bomboletta lubrificante per o-ring.  
 Slide silicon lubricant for o-ring in fittings.

Codice	Articolo	Confezione (pz)	€/cad
W4330005	SIL	2	20,22

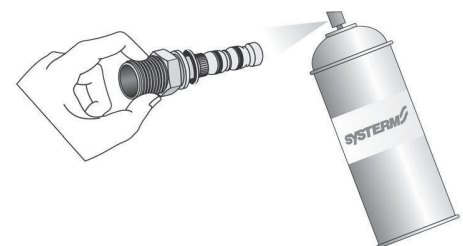

## 3b. Utensili vari - 3b. Tools

3.1 - Tagliatubi per tubo WELCO-Flex. Diametro max 50 mm. Rotella di ricambio RRW50.  
Multi-layer cutter pipe. For cutting correctly max DN 50. Spare cutting wheel RRW50.

Codice	Articolo	Confezione (pz)	€/cad
W3015000	TAW50 (Utensile)	1	34,48
W3015010	RRW50 (Rotelle)	5	6,74

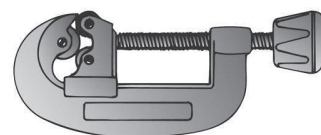

3.10 - Tagliatubi Super per tubo WELCO-Flex. Diametro max 63 mm. Rotella di ricambio RRW63.  
Super multi-layer cutter pipe. For cutting correctly max DN63. Spare cutting wheel RRW63.

Codice	Articolo	Confezione (pz)	€/cad
W3106300	TAW63 (Utensile)	1	113,44
W3106310	RRW63 (Rotelle)	5	12,92

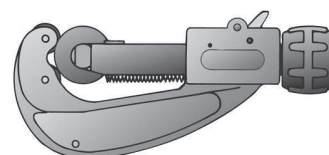

3.11 - Tagliatubi Special per tubo WELCO-Flex. Diametro max 40 mm. Rotella di ricambio RSW32.  
Special multi-layer cutter pipe. For cutting correctly max DN40. Spare cutting wheel RSW32.

Codice	Articolo	Confezione (pz)	€/cad
W3113200	TAW32 (Utensile)	1	108,77
W3113210	RSW32 (Rotelle)	5	23,59

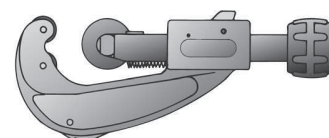

3.21A - Punzone alesatore non tagliente. In acciaio inox; impugnatura in plastica.  
Calibrating tool. Stainless steel, no cutting, with plastic handle.

Codice	Articolo	Per tubo	Confezione (pz)	€/cad
P321A011	IKZ11	11,6x1,5	1	41,68
M321A014	IKZ14	14x2,00	1	42,84

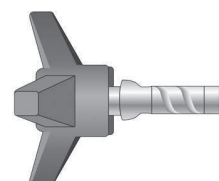

## 3b. Utensili vari - 3b. Tools

3.21 - Punzone alesatore. In acciaio. Impugnatura in plastica.  
*Calibrating tool. In steel with plastic handle.*

Codice	Articolo	Per tubo	Confezione (pz)	€/cad
W3211610	WKZ16	16x2,25	1	68,58
W3212010	WKZ20	20x2,50	1	72,47
W3212600	WKZ26	26x3,00	1	103,57
W3213200	WKZ32	32x3,00	1	117,22
W3214000	WKZ40	40x3,50	1	126,84
W3215000	WKZ50	50x4,00	1	139,21
W3216300	WKZ63	63x4,50	1	193,1
M3211610	MKZ16	16x2,00	1	68,58
M3212010	MKZ20	20x2,00	1	72,47



## 3.22 - Punzone alesatore montabile su mandrino. In acciaio. Impugnatura in plastica.

Codice	Articolo	Per tubo	Confezione (pz)	€/cad
W3221600	WK016	16x2,25	1	46,00
W3222000	WK020	20x2,50	1	59,00
W3223200	WK026	26x3,00	1	79,00
W3222600	WK032	32x3,00	1	103,00
W322SET1	WKSET	16 / 20 / 26 / 32	1	258,00

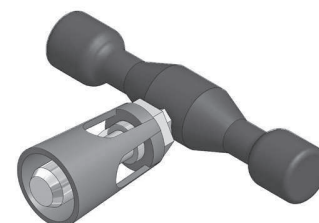
3.22 - Coltello sbavatore.  
*Deburring cutter.*

Codice	Articolo	Confezione (pz)	€/cad
W3220000	SBV	1	17,92



## 3b. Utensili vari - 3b. Tools

3.23 - Coppia morsetti ferma tubo, DN 20-26-32-40-50-63.  
Couple clamps stop-pipe for DN 20-26-32-40-50-63.

Codice	Articolo	Per tubo	Confezione (pz)	€/cad
W3232040	EM40	20 / 26 / 32 / 40	1	74,88
W3235063	EM63	50 / 63	1	74,88

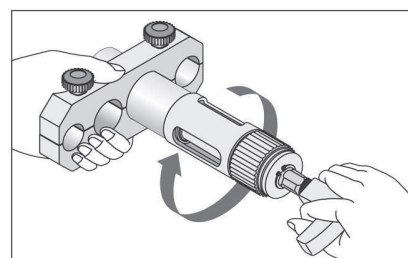
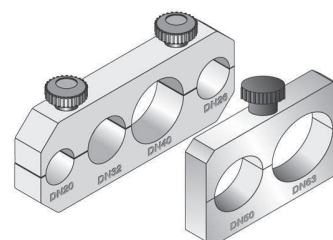
3.6 - Piegatubi manuale DN16-20-26. In valigetta plastica.  
Handle bending pipe DN 16-20-26. Including plastic case.

Codice	Articolo	Confezione (pz)	€/cad
W3061626	CPT 16/26	1	340,00

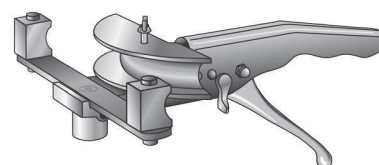
3.61 - Piegatubi manuale. DN 14-16-20-26-32. In valigetta metallica.  
Handle bending pipe DN 14-16-20-26-32. Including plastic case.

Codice	Articolo	Confezione (pz)	€/cad
W3061632	CPT 14/32	1	559,00

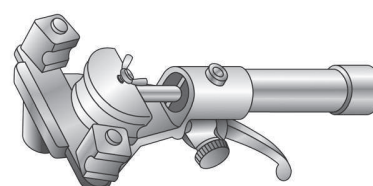



## 3b. Utensili vari - 3b. Tools

## 3.61/A - Forma e controforma per sorpasso DN20 e DN26. Utilizzabili nel piegatubi 3.61.

Form and contrary form for overtaking pipe DN 20-26. Utilizable with handle bending 3.61.

Codice	Articolo	Per tubo	Confezione (pz)	€/cad
W3162032	SOR20	20	1	205,91
W3162632	SOR26	26	1	243,85

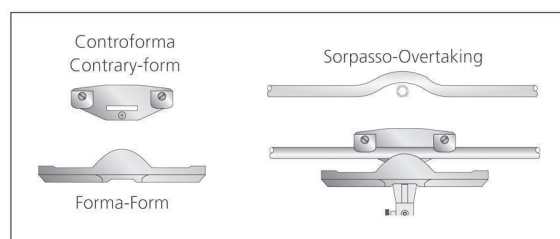
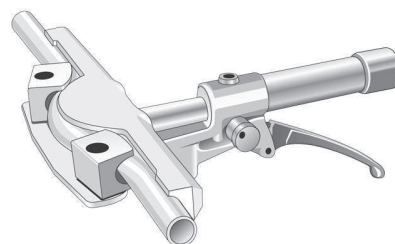
3.62 - Piegatubi manuale in plastica. Raggio di curvatura ridottissimo ( $R=1,5d$ )\* per tubo 16 x 2,0 e 16 x 2,25.

Plastic handle bending. Very small ray =  $1,5d^*$ , only for pipe 16x2,25 or 16x2,0.

Codice	Articolo	Confezione (pz)	€/cad
W3062160	SPP16	1	€ 48,00

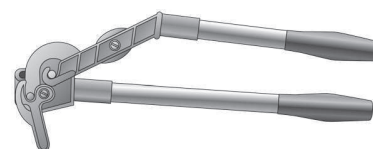

## 3.7 - Molle piegatubi in acciaio zincato.

Bending spring.

Codice	Articolo	l	Confezione (pz)	€/cad
W3071400	M 14	600	1	20,67
W3071600	M 16(1)	600	1	21,05
W3072000	M 20(1)	600	1	22,22
W3071419	M 14	1900	1	31,79
W3071619	M 16(1)	1900	1	63,01
W3072019	M 20(1)	1900	1	65,26

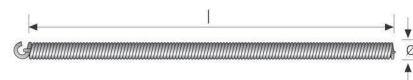

## 3b. Utensili vari - 3b. Tools

3.63 - Piegatubi manuale meccanico a manovella. Per tubo WELCO-Flex DN 32, DN 40 e DN 50. Valigetta in legno.  
*Mechanical handle bending by winch. For pipe DN32-40-50, including wood case.*

Codice	Articolo	Confezione (pz)	€/cad
W3063240	CPT 32/40	1	1.720,00
W3063250	CPT 32/40/50	1	1.910,00
W3060050	MTR DN50(1)	1	520,00

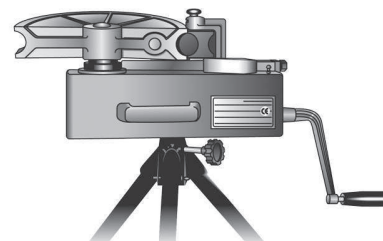

3.64 - Piegatubi elettrica in tubo DN 20-26-32 in cassetta metallica.  
*Electical bending for pipe DN 20-26-32 in metallic case.*

Codice	Articolo	Confezione (pz)	€/cad
W3641632	CUR-SET 16-32	1	1.890,00
W3640040	MATR-40(1)	1	335,00

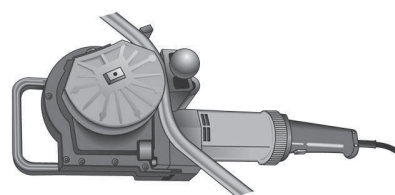

3.9N - Pressatrice EFP2. Pressatrice elettrica Novopress 220V; 50-60Hz. Potenza assorbita 560W.  
 Forza pistone 32kN. Testa girevole. Completa di valigetta metallica.  
*Press tool EFP2. Electrical tool, 220 V, 50/60 Hz, Power consumption 560W.  
 Piston force 32kN, revolving head. Metallic case.*

Codice	Articolo	Confezione (pz)	€/cad
WEL81903	EFP2	1	2.449,00

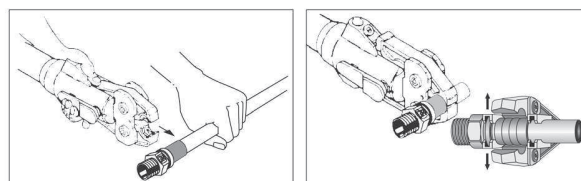
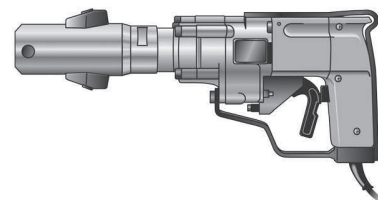

## 3b. Utensili vari - 3b. Tools

**3.98.1N - Combinazione EFP2 con pinze DN 16-20-26. Testa girevole. Combinazione comprendente pressatrice Novopress EFP2, pinze di pressatura per raccordi WOPREX e valigetta metallica.**  
*Set EFP2 with jaws DN16-20-26. Revolving head. Set Novopress tool EFP 2 and jaws for WOPREX fittings in metallic case.*

Codice	Articolo	Comprendente	Confezione (pz)	€/cad
WCOMB01N	3.98.1N	N° 1 WEL81903	1	3.368,00
		N° 1 WNPX1600		
		N° 1 WNPX2000		
		N° 1 WNPX2600		

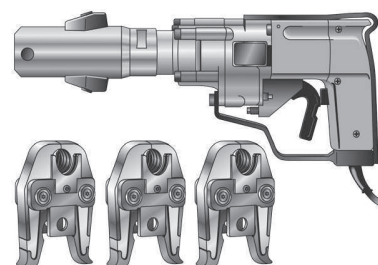

**3.99/A - Pressatrice EFP 202. Pressatrice elettrica Novopress. Tensione 220V; 50-60Hz. Potenza assorbita 400 W. Forza pistone 32 kN. Testa girevole, completa di valigetta plastica. Garanzia 3 anni.**  
*Press tool EFP201. Electrical NOVOPRESS tool, 220 V, 50/60 Hz, Power consumption 510W, Piston force 32kN, revolving head, plastic case. Warranty 3 years.*

Codice	Articolo	Confezione (pz)	€/cad
WEL81920	EFP 202	1	1.679,00



**3.98/B - Pressatrice AFP 202. Pressatrice elettrica Novopress a batteria. Tensione 14V; Potenza 400W. Forza pistone 32 kN. Batterie, capacità 2,0Ah per ca. 80 pressature (tempo di ricarica 50 min). Testa girevole. Valigetta plastica e carica batteria. Garanzia 3 anni.**  
*Cordless press tool ACO 201. Electrical Novopress battery tool, powerful 14V, Power consumption 400W, Piston force 32kN, battery capacity 60/80 press cycles, charging time 50 min. Revolving head. Charging battery and plastic case. Warranty 3 years.*

Codice	Articolo	Confezione (pz)	€/cad
WEL81921	AFP 202	1	1.898,00



## 3b. Utensili vari - 3b. Tools

**3.9E - Pressatrice E2001.** Pressatrice elettrica portatile. Tensione 220÷230V; 50÷60Hz.  
 Potenza: assorbita 700W - 3,3A. Testa girevole. Valigetta metallica.  
*Press tool E2001. Electrical CBC presstool, 220V, 50÷60 Hz, Power consumption 700 W-3,3A.  
 Rotary press head, plastic case.*

Codice	Articolo	Confezione (pz)	€/cad
WEL81909	CBC-E2001	1	1.384,00

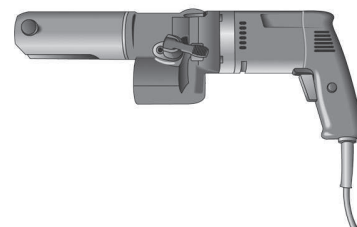

**3.9B - Pressatrice 98/B.** Pressatrice elettrica a batteria 18V. Testa girevole completa di batteria, carica batteria, valigetta plastica.  
*Battery press tool 98/B. Electrical CBC battery tool, powerful 18V, rotary press head, charging battery, plastic case.*

Codice	Articolo	Confezione (pz)	€/cad
WEL81910	CBC-98/B	1	1.853,00

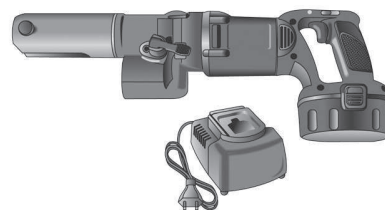

**3.95/E - Combinazione E2001 con pinze.** Combinazione comprendente: pressatrice CBC E2001, pinze di pressatura (DN 16-20-26) per raccordi WOPREX, valigetta di plastica.  
*Set E2001 with jaws. Set CBC presstool with jaws DN16-20-26 for WOPREX fittings and plastic case.*

Codice	Articolo	Comprendente	Confezione (pz)	€/cad
WCOMB01A	CBC-3.95/E	N° 1 WEL81909	1	1.998,00
		N° 1 WPREX016		
		N° 1 WPREX020		
		N° 1 WPREX026		

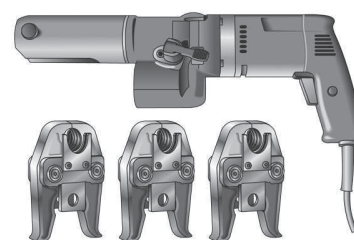

## 3b. Utensili vari - 3b. Tools

3.95/B - Combinazione 98/B con pinze. Combinazione comprendente: pressatrice CBC 98/B a batteria, pinze di pressatura DN 16-20-26 per raccordi WOPREX, carica batteria e valigetta plastica.

*Set 98/B with jaws. Set CBC presstool 98/B, one battery, charging battery with jaws DN16-20-26 for WOPREX fittings in plastic case.*

Codice	Articolo	Comprendente	Confezione (pz)	€/cad
WCOMB01B	CBC-3.95/B	N° 1 WEL81910	1	2.486,00
		N° 1 WPREX016		
		N° 1 WPREX020		
		N° 1 WPREX026		

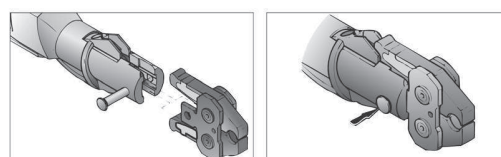
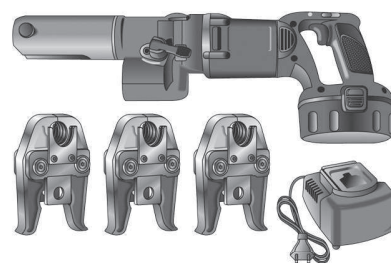

6.92 - SYSTERM - Legatrice automatica. Per fissaggio tubi PEX DN 25 e 20 alla rete elettrosaldata. Completa di n° 2 batterie ricaricabili 9,6 V, caricabatterie, valigetta per il trasporto e n° 2 bobine di filo.

*Automatic tier. To fixing PEX pipe DN 25/20 to net with n° 2 Ni-Cd batteries 9,6V, recharge battery, plastic case and 2 steel wire.*

Codice	Articolo	Confezione (pz)	€/cad
P6920000	RB392 (Utensile)	1	858,00
P6920095	TW95 (Bobina 95m)	1	4,96

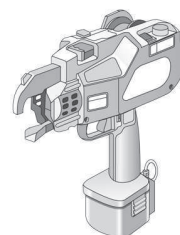

## 3b. Utensili vari - 3b. Tools

3.91 - Pinze PDN di pressatura per raccordi WOPREX in acciaio speciale.  
*Jaws PDN. jaws press for WOPREX fittings.*

Codice	Articolo	Confezione (pz)	€/cad
WPREX011	PDN11	1	248,00
WPREX014	PDN14	1	248,00
WPREX016	PDN16	1	248,00
WPREX017	PDN17	1	248,00
WPREX020	PDN20	1	248,00
WPREX026	PDN26	1	269,00
WPREX032	PDN32	1	269,00
WPREX040	PDN40	1	702,00

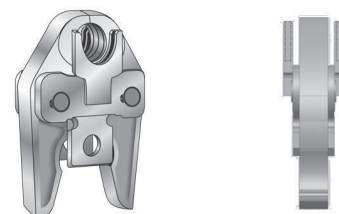
3.96 - WO-Prex - Pinze PDN..N di pressatura per raccordi WOPREX, con guida da una parte.  
*Jaws PDN..N. Novopress jaws press for WOPREX fittings, with one guiding plate.*

Codice	Articolo	Confezione (pz)	€/cad
WNPX1600	PDN16-N	1	326,00
WNPX2000	PDN20-N	1	332,00
WNPX2600	PDN26-N	1	336,00
WNPX3200	PDN32-N	1	342,00

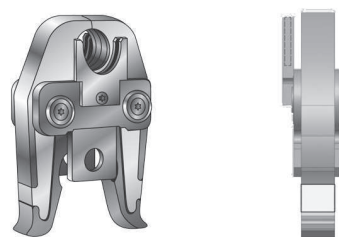
3.97 - WO-Prex - Pinze di pressatura Novopress raccordi WOPREX DN 40, 50 e 63.  
*Press jaws PPN. Press jaws Novopress for WOPREX fittings DN40-50-63.*

Codice	Articolo	Confezione (pz)	€/cad
WPPN4563	PPN 43 Adattatore per DN40/50/63	1	278,00
WPPN0040	PPN 40 <sup>(1)</sup>	1	748,00
WPPN0050	PPN 50 <sup>(1)</sup>	1	1.129,00
WPPN0063	PPN 63 <sup>(1)</sup>	1	1.819,00



## 3b. Utensili vari - 3b. Tools

3.97N - WO-Prex - Pinze WNTX Pinze di pressatura per raccordi WOPREX DN 40, 50 e 63. Set comprendente adattatore (PPN43), pinze e valigetta metallica.

*Press jaws WNTX. Press jaws Novopress for WOPREX fittings DN40-50-63. Set with adaptor (PPN43), jaws and metallic case.*

Codice	Articolo	Descrizione	Confezione (pz)	€/cad
WNTX4000	WNTX 40	Set DN 40	1	1.152,00
WNTX5000	WNTX 50	Set DN 50	1	1.513,00
WNTX6300	WNTX 63	Set DN 63	1	2.199,00
WNTX4050	WNTX 45	Set DN 40-50	1	2.279,00
WNTX4300	WNTX 43	Set DN 40-50-63	1	4.098,00
WNTX5300	WNTX 53	Set DN 50-63	1	3.352,00

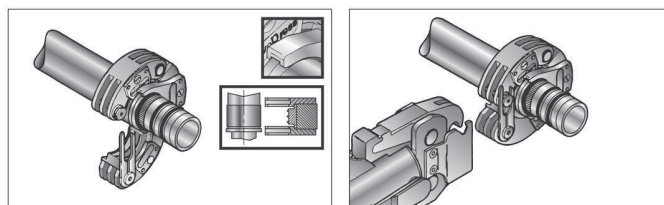
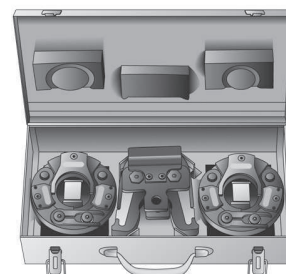

3.95/D - WO-Prex - Batterie.  
*Batteries.*

Codice	Articolo	Confezione (pz)	€/cad
WELBATT.C	3.9B (CBC)	1	296,00
WELBATT.N	3.98 (NOVOPRESS AC021)	1	249,00
WELBATT.N1	3.98/B (NOVOPRESS AFP202) 2,0 Ah NiCd	1	259,00
WELBATT.N2	3.98/B (NOVOPRESS AFP202) 3,0 Ah Li Ion	1	376,00



3.95/E - WO-Prex - Manometro per test pressatrice CBC.  
*Manometer for testing tool CBC.*

Codice	Confezione (pz)	€/cad
WELCONTR	1	119,00





## 3b. Utensili vari - 3b. Tools

**3.8N - Pressatrice Novopress AFP 101, a batteria, capacità 1,3 Ah. Potenza assorbita 240W. Forza pistone 19 kN. Peso con pinza e batteria 2,3 kg, utilizzabile per raccordi WOPREX max DN 32 (solo con pinze PNN). Completa di valigetta in plastica e carica batteria.**  
*Novopress battery tool AFP 101, capacity 1,3 Ah. Power consumption 240 W. Piston force 19 kN. Weight with batteria e pinza 2,3 Kg, for pressing WOPREX fittings, max DN 32 (only with Jaws PNN). With plastic case for four jaws and charging battery.*

Codice	Articolo	Confezione (pz)	€/cad
WEL81913(1)	AFP101	1	1.819,00

**3.88R - Ricambi Novopress per AFP 101.**  
*Spare parts for Novopress AFP101.*

Codice	Articolo	Descrizione	Confezione (pz)	€/cad
WAFP101B	Carica batteria	AFP101	1	229,00
WBAT101B	Batteria 3,0 Ah	AFP101	1	259,00

A mm	B mm	C mm
350	62	80

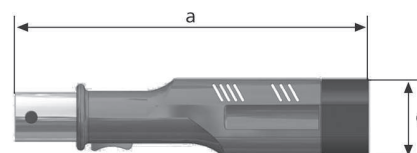
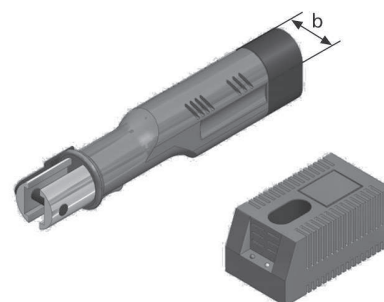

**3.88N - Pinze PNN Novopress alleggerite, guida per raccordi WOPREX da un lato, (utilizzabili solo con AFP101) in acciaio speciale.**  
*Novopress PNN light jaws, with one guiding plate, (utilizable only with AFP 101) made special steel.*

Codice	Articolo	Confezione (pz)	€/cad
WPNNX016	PNN 16	1	239,00
WPNNX020	PNN 20	1	239,00
WPNNX026	PNN 26	1	239,00
WPNNX032	PNN 32	1	265,00

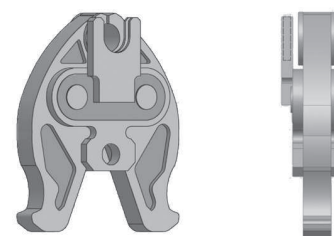

**3.88P - Combinazione Novopress AFP101, valigetta in plastica con 2-3-4 pinze PNN, una batteria 3,0 Ah e carica batteria.**  
*Set AFP101 with 2-3-4 jaws PNN, battery 3,0 Ah and charging bat.*

Codice	Articolo	Descrizione	Confezione (pz)	€/cad
WCOMB02N	3,88 2P	(PNN 16 e 20)	1	2.289,00
WCOMB03N	3,88 3P	(PNN 16-20 e 26)	1	2.399,00
WCOMB04N	3,88 4P	(PNN 16-20-26 e 32)	1	2.697,00

